

# EVER❄CHILL

## Built-in Vehicle FROST-FREE REFRIGERATOR-FREEZER

### INSTRUCTION MANUAL

Model No.: SRM-418CB-C

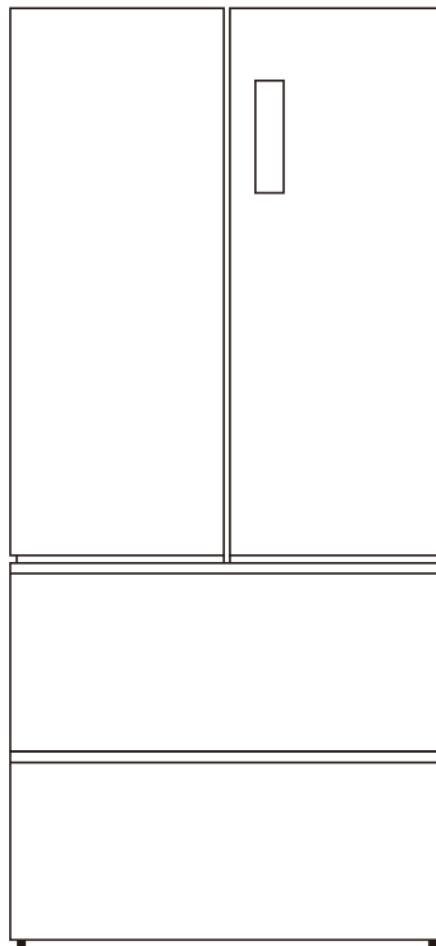

Dear users, this manual contains the product's basic knowledge, how to use it, fault diagnosis and basic troubleshooting methods. In order to better understand and use this product, please take good care of this manual, and read it carefully.

# CONTENTS

<b>I. IMPORTANT SAFETY INSTRUCTIONS .....</b>	<b>3</b>
<b>II. FEATURES AND PARTS .....</b>	<b>5</b>
<b>III. PREPARATIONS FOR USE .....</b>	<b>5</b>
<b>IV. FUNCTIONS.....</b>	<b>6</b>
<b>V. INSTRUCTIONS FOR FOOD STORAGE .....</b>	<b>8</b>
<b>VI. TIPS FOR SPECIAL NEEDS.....</b>	<b>9</b>
<b>VII. MAINTENANCE AND CLEANING.....</b>	<b>10</b>
<b>VIII. SIMPLE FAULT ANALYSIS AND ELIMINATION.....</b>	<b>11</b>

## I. IMPORTANT SAFETY INSTRUCTIONS

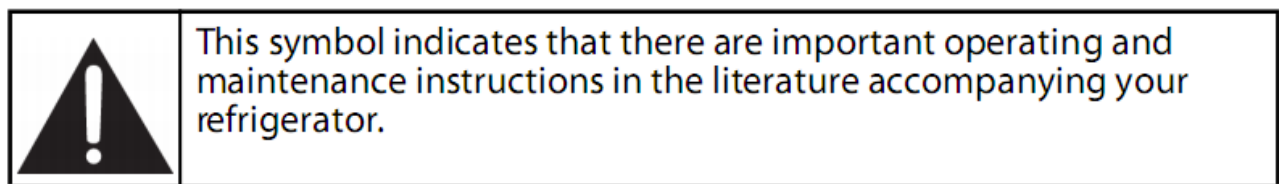
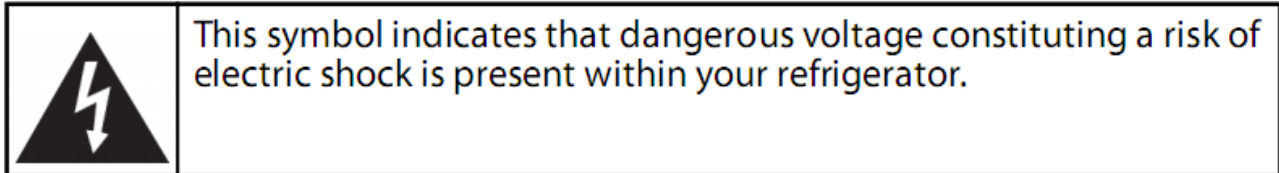
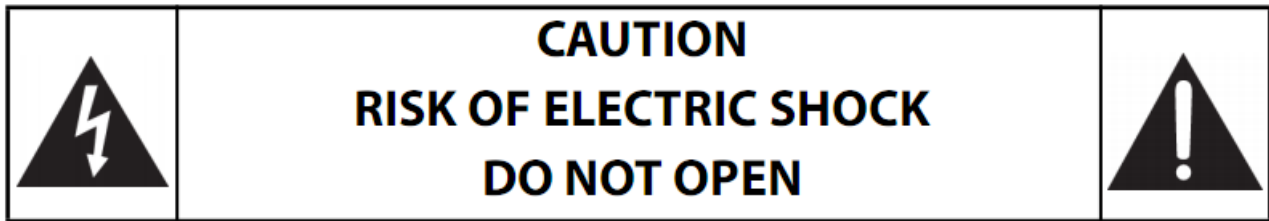

### WARNINGS

1. Read these instructions.
2. Keep these instructions.
3. Heed all warnings.
4. Follow all instructions.
5. Do not use your refrigerator near water.
6. Clean only with a damp cloth.
7. Do not block any ventilation openings. Install in accordance with the manufacturer's instructions.
8. Do not install near any heat sources, such as radiators, heat registers, stoves, or other apparatus (including amplifiers) that produce heat.
9. Refer all servicing to qualified service personnel. Servicing is required when your refrigerator has been damaged in any way, such as liquid has been spilled or objects have fallen into your refrigerator, your refrigerator has been exposed to rain or moisture, does not operate normally, or has been dropped.
10. To reduce the risk of fire or electric shock, do not expose your refrigerator to rain, moisture, dripping, or splashing, and no objects filled with liquids should be placed on top of it.
11. Your refrigerator is not intended for use by persons (including children) with reduced physical, sensory, or mental capabilities, or lack of experience and knowledge, unless they have been given supervision or instruction concerning use of your refrigerator by a person responsible for their safety.
12. Children should be supervised to ensure that they do not play with your refrigerator.



### ELECTRIC SHOCK HAZARD

**Failure to follow these instructions can result in electric shock, fire, or death.**

**1.WARNING**—Keep ventilation openings, in both your refrigerator and the built-in structure, clear of obstruction.

**2.WARNING**—Do not touch the interior of your refrigerator with wet hands. This could result in frostbite.

**3.WARNING**—Do not use mechanical devices or other means to accelerate the defrosting process, other than those recommended by the manufacturer.

**4.WARNING**—Do not damage the refrigerant circuit.

**5.WARNING**—Do not damage the refrigerant tubing when handling, moving, or using your refrigerator.

**6.WARNING**—DANGER—Never allow children to play with, operate, or crawl inside your refrigerator.

**Risk of child entrapment. Before you throw away your old refrigerator:**

- Take off the door.

- Leave the shelves in place so that children may not easily climb inside.

**7. WARNING**—Do not use electrical appliances inside the food storage compartments of the appliance unless they are of

the type recommended by the manufacturer.

**8. WARNING-**To avoid a hazard due to instability of the appliance, it must be fixed in accordance with the instructions.

**9.** Power source disconnected your refrigerator before carrying out user maintenance on it.

**10.** If a component part is damaged, it must be replaced by the manufacturer, its service agent, or similar qualified persons in order to avoid a hazard.

**11.** Follow local regulations regarding disposal of your refrigerator due to flammable refrigerant and gas. All refrigeration products contain refrigerants, which under the guidelines of federal law must be removed before disposal. It is the consumer's responsibility to comply with federal and local regulations when disposing of this product.

**12.** Do not store explosive substances such as aerosol cans with a flammable propellant in this appliance.

**13.** This appliance is intended to be used in the recreational vehicle.

**14.** Disposal of your old appliance: By ensuring this product is disposed of correctly, you will help prevent potential negative consequences for the environment and human health, which could otherwise be caused by inappropriate waste handling of this product. For more detailed information, please contact your local city office, your household waste disposal service or the shop where you purchased the product.

**15.** If the SUPPLY CORD is damaged, it must be replaced by the manufacturer, its service agent or similarly qualified persons in order to avoid a hazard.

**16.** There is a power switch for the refrigerator. Before any maintenance, please disconnect the switch.

### **⚡WARNING⚡**

This appliance should be properly grounded for your safety. The power cord of this appliance is equipped with a three-prong plug which mates with the standard three prong wall outlets to minimize the possibility of electrical shock.

Do not, under any circumstances, cut or remove the third ground prong from the power cord supplied.

This refrigerator appliance requires a standard 115VAC /60Hz electrical outlet with three-prong ground.

This refrigerator appliance is not designed to be used with an inverter.

The cord should be secured behind the appliance and not left exposed or dangling to prevent accidental injury.

Never unplug the refrigerator by pulling the power cord. Always grip the plug firmly and pull straight out from the receptacle.

Do not use an extension cord with this appliance. If the power cord is too short, have a qualified electrician or service technician install an outlet near the appliance. Use of an extension cord can negatively affect the performance of the unit. Improper use of the grounded plug can result in the risk of electrical shock. If the power cord is damaged, have it replaced by an authorized service center.

## II. Features and parts

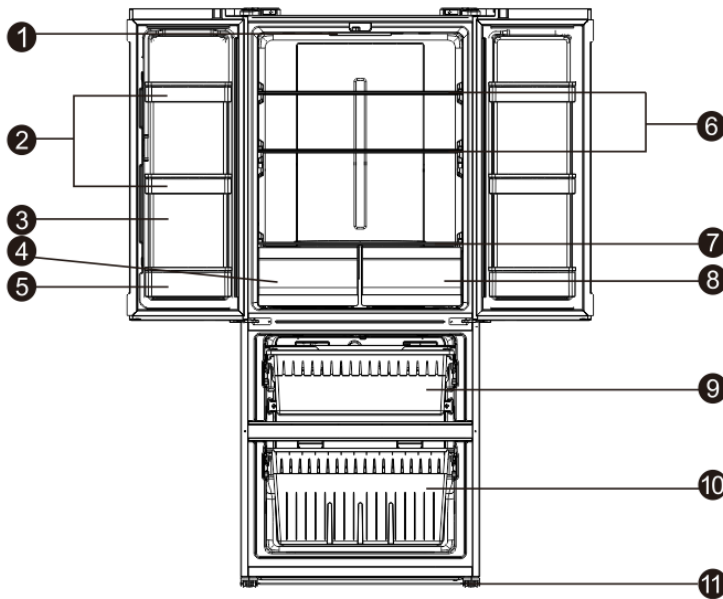

- ① Lamp    ② Upper Balcony on Fridge Door    ③ Fridge Door    ④ Crisper
- ⑤ Lower Balcony on Freezer Door    ⑥ Glass Shelf    ⑦ Crisper Cover    ⑧ Crisper
- ⑨ Upper Freezer Compartment    ⑩ Lower Freezer Compartment
- ⑪ Adjustable Feet

Due to technological innovations, the product descriptions in this manual may not be completely consistent with your refrigerator. Detailed information is in accordance with the final product.

## III. Preparations for use

### Installation location:

#### 1. Ventilation condition

The position you select for the refrigerator installation should be well-ventilated and has less hot air. Do not locate the unit near a heat source such as cooker, and avoid it from direct sunlight, thus guaranteeing the refrigerator effect while saving energy consumption. Do not locate the refrigerator in the damp place, so as to prevent it from rusting and leaking electricity.

Note: The amount of refrigerant charged for the unit can be found on the nameplate.

#### 2. Heat dissipation space

When working, the unit gives off heat to surroundings. Therefore, at least 300mm(11.8") of free space should be spared at the top side, more than 100mm(3.9") on both sides, and above 50mm(2") at the side of the refrigerator.

Dimensions suggested below:

W	D	H	A	B	C(°)	E	F
753(29.6")	678(26.7")	1846(72.7")	1188(46.8")	1000(39.4")	122	50(2")	200(7.9")

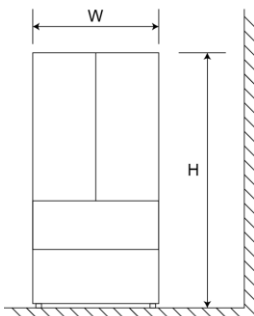

Fig. 1

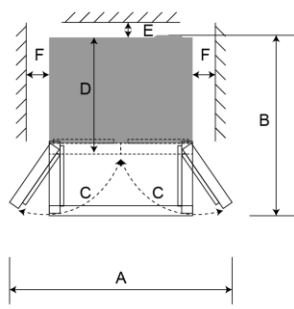

Fig. 2

Note: Figure 1, Figure 2 only illustrate the space demand of the product.

### 3. Level ground

Place the refrigerator on the solid and flat ground (floor) to keep it stable, or else, it will give rise to vibration and noise. When the refrigerator is placed on such flooring materials as carpet, straw mat, polyvinyl chloride, the solid backing plates should be applied underneath the unit, so as to prevent color change due to heat dissipation.

### 4. Fixing the refrigerator to the closet

The user can install the screw into the holes on the inner cabinet to fix the refrigerator to the RV closet, pls see below photos:

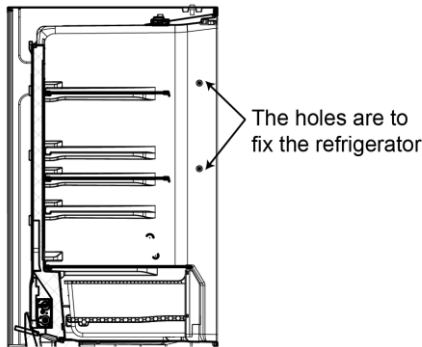

### 5. Fixing the glass shelves in the refrigerator room

The glass shelves in the refrigerator room will be fixed in the production. For the safety consideration, the glass shelves are prohibited to move.



**Unobstructed ventilation shall be maintained around the unit or in an embedded structure.**

## Preparations for use

#### 1. Standing time

After the refrigerator is properly installed and well cleaned, do not switch it on immediately. Make sure to energize the refrigerator after more than 1 hour's standing, so as to ensure its normal operation.

#### 2. Cleaning

Confirm the accessory parts inside the refrigerator and wipe the inside with a soft cloth.

#### 3. Power-on

Connect the refrigerator power supply to the dedicated power supply in the RV, then the compressor starts working. After 1 hour, open the freezer door, if the compartment internal temperature drops significantly, it indicates the refrigeration system is working normally.

#### 4. Storage of food

After the refrigerator runs for a period of time, the internal temperature of the refrigerator will be automatically controlled according to the user's temperature setting. After the refrigerator is fully cooled, put in foods, which usually need 2~3 hours to be fully cooled. In summer, when the temperature is high, it takes more than 4 hours for the foods to be fully cooled (Try to open the refrigerator door as less as possible before the internal temperature cools down).



**When used in an ambient temperature of higher than 50 °C, in order to guarantee the service life and function of the electronic components of the refrigerator, it may not get started at the first time or not be cooling.**

## IV. Functions

### CONTROL PANEL

Use your appliance according to the following control regulations, your appliance has the corresponding functions as the control panels showed in the pictures below.

### OPERATION DESCRIPTION

Press "unlock" button for 3 seconds to be unlock state, then you can press other buttons for operation. Touch the "ROOM" button, the light of the current room will flash, and then press the "ROOM" button again, you can choose between the fridge room and freezer room. If there is no operation for more than 5S, the current function will be started.

Under unlock state, touch the "TEMPERATURE" button, the temperature of compartments will be changed accordingly. Press "MODE" button shortly to select the different modes.

#### 1) Temperature display

Every time when the refrigerator system is powered up, the setting temperature of the refrigerator will be displayed in Fahrenheit by default. When the display is under "lock" state, you can switch between

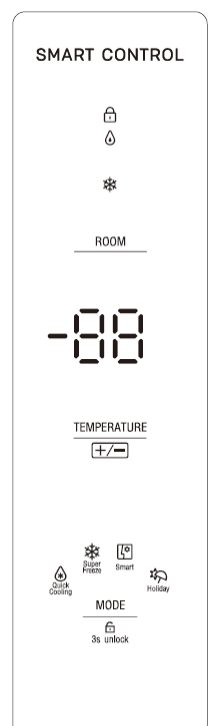

the Fahrenheit display and the Celsius display by holding down the "ROOM" key for 5s.

Correspondence between the temperatures goes as follows

Fridge temp. display		Freezer temp. display	
Fahrenheit (°F)	Celsius (°C)	Fahrenheit (°F)	Celsius (°C)
34	1	3	-16
35	1	2	-17
36	2	1	-17
37	2	0	-18
38	3	-1	-18
39	3	-2	-19
40	4	-3	-20
41	5	-4	-20
42	5	-5	-21
43	6	-6	-21
		-7	-22
		-8	-22

## 2) Fridge temperature setting

Under unlock state, press the "ROOM" key to select the fridge zone until the corresponding icon gets flickering, and then press the "TEMPERATURE" key to set the temperature as desired, after the icon stop flickering, the setting will take effect.

The fridge temperature setting cycles as following:

3°C→4°C→5°C→6°C→OF→1°C→2°C→3°C;

38°F→39°F→40°F→41°F→42°F→43°F→OF→34°F→35°F→36°F→37°F→38°F

OF indicates the fridge is switched off, and when the OF function takes effect, the fridge will stop cooling.

## 3) Freezer temperature setting

Under unlock state, press the "ROOM" key to select the freezer zone until the corresponding icon gets flickering, and then press the "TEMPERATURE" key to set the temperature as desire, after the icon stop flickering, the setting will take effect.. The freezer temperature setting cycles as following:

-22°C→-21°C→-20°C→-19°C→-18°C→-17°C→-16°C→-22°C;

-8°F→-7°F→-6°F→-5°F→-4°F→-3°F→-2°F→-1°F→0°F→1°F→2°F→3°F→-8°F

## MODE DESCRIPTION

### MODE SETTING

Under unlock state, the current mode will flash. You can choose between smart, quick cooling, super freeze, and holiday four modes by pressing the "MODE" button. If there is no operation for more than 5S, the current mode on the display will start, then the settings take effect.

### SMART COOLING MODE

The refrigerator will adjust the temperature automatically according to the ambient temperature and the temperature inside the refrigerator, you do not have to choose the temperature by yourself, save your time and effort.

#### 1) Enabling the Smart Cooling mode

◆ Press the "MODE" key to select Smart Cooling mode until the corresponding icon gets flickering. When the icon stops flickering, the Smart cooling mode will be valid.

#### 2) Exiting the Smart Cooling mode

◆ Under the Smart cooling mode, press the "MODE" key to make the corresponding icon get flickering, then press the "MODE" key and select other mode. The Smart cooling function will exit.

◆ When the Holiday or Super Freeze function is enabled, the Smart Cooling mode will be disabled automatically.

### QUICK COOLING MODE

In this mode, the temperature of fridge compartment will reach setting temperature quickly, which will help to keep the food fresh. If you want to put much food in the refrigerator at once, please choose this mode.

#### 1) Enabling the Quick Cooling mode

◆ Press the "MODE" key to select Quick Cooling mode until the corresponding icon gets flickering. When the icon stops flickering, the Quick Cooling mode will be valid

#### 2) Exiting the Quick Cooling mode

◆ Under the Quick Cooling mode, press the "MODE" key to make the corresponding icon get flickering, then press the "MODE" key and select other mode. The Quick Cooling mode will exit.

### SUPER FREEZE MODE

The food will be frozen in a short time. Note: This mode has a duration of 6 hours and a duration of 48 hours for both time modes to be chosen. When entering the super freeze function normally, it defaults to a 6 hour quick time mode. If you need to enter the 48 hour super freeze function you also need to do the following: when the super freeze function has

been effective, press the "ROOM" button for 5 seconds, enter the set frozen time selection, frozen temperature display area display the current freezing time (unit: hours), the remaining icons are not displayed; then press the "ROOM" key for 5s to set the super freeze time, by pressing the "MODE" key, you can set the order of 48-6-48...-6 cycles. 5s no key operation, the current setting will take effect, and return to the normal state. Super Freeze mode takes effect immediately after you have finished setting, and automatically exits and returns to normal control when the super freeze time is up.

1) Enabling the Super Freeze mode

- ◆ Press the "MODE" key to select Super Freeze mode until the corresponding icon gets flickering. When the icon stops flickering, the Super Freeze mode will be valid.

2) Exiting the Super Freeze mode

- ◆ Under the Super Freeze mode, press the "MODE" key to make the corresponding icon get flickering, then press the "MODE" key and select other mode. The Super Freeze mode will exit.

**HOLIDAY MODE**

When you and your family intend to go on holiday, you can choose this mode. The fridge and freezer compartment will match the appropriate temperature in this mode automatically.

1) Enabling the Holiday mode

- ◆ Press the "MODE" key to select Holiday mode until the corresponding icon gets flickering. When the icon stops flickering, the Holiday mode will be valid

2) Exiting the Holiday mode

- ◆ Under the Holiday mode, press the "MODE" key to make the corresponding icon get flickering, then press the "MODE" key and select other mode. The Holiday mode will exit.



**Be sure to take out all foods from the fresh food compartment before setting this function.**



**Under the Holiday mode, the fridge temperature is subject to no change.**

**FAULT DISPLAY**

Fault display shows as following under Fault mode:

ERROR CODE	ERROR TYPE
UC	Communication failure or model mismatch
RS	Sensor failure (refrigerating chamber)
CS	Sensore failure (Drinks box)
FS	Sensor failure (freezing chamber)
Fd	Defrosting sensor failure
FF	Fan failure
ES	Failure of ambient temperature sensor

**V. Instructions for food storage**

**Precautions for use**

- The appliance might not operate consistently (there is possibility of defrosting or temperature becoming too warm in the frozen food compartment) when sited for an extended period of time below the cold limit of the temperature range for which the refrigerating appliance is designed
- The internal temperature could be affected by such factors as the location of refrigerating appliance, ambient temperature, and frequency of door open, etc., and if appropriate, a warning that setting of any temperature control device might have to be varied to allow for these factors should be made.
- Effervescent drinks should not be stored in the freezer compartment or the low-temperature compartment.

**Food storage location**

Due to the cold air circulation in the refrigerator, the temperature of each area in the refrigerator is different, so different kinds of food should be placed in different areas.

The fresh food compartment is suitable for the storage of such food as need not to be frozen, the cooked food, beer, eggs, some condiments that need cold preservation, milk, fruit juice, etc. The crisper box is suitable for the preservation of vegetables, fruits, etc.

The freezer compartment is suitable for the storage of ice cream, frozen food and the foods to be preserved for a long time.

### **Use of the fresh food compartment**

Crisper box: Pull out the crisper box for access to food. After using or cleaning the cover plate of the crisper box, be sure to put it back onto the crisper, so that the internal temperature of the crisper box will not be affected.

### **Cautions for food storage**

You'd better clean the foods and wipe them dry before storing them inside the refrigerator. Before foods are put in the refrigerator, it is advisable to seal them up, so as to prevent water evaporation to keep fresh fruits and vegetables on one hand, and prevent taint of odor on the other hand.

Do not over pack the refrigerator compartment. Keep enough space between foods; if too close, the cold air flow will be blocked, thus affecting the refrigeration effect. Do not store excessive or overweight foods, to avoid the shelf from being crushed. When storing the foods, keep a distance away from the inner wall; and do not place the water-rich foods too close to the fridge rear wall, lest they get frozen on the inner wall.

Categorized storage of foods: Foods should be stored by category, with the foods you eat every day placed in front of the shelf, so that the door open duration can be shortened and food spoilage due to expiration can be avoided.

Energy-saving tips: Allow hot food to cool down to room temperature before putting it in the refrigerator. Put the frozen food in the fresh food compartment to thaw, using the low temperature of the frozen food to cool the fresh food, thus saving energy.

### **Storage of fruits and vegetables**

In the case of refrigerating appliances with chill compartment, a statement to the effect that some types of fresh vegetables and fruits are sensitive to cold and therefore are not suitable for storage in this kind of compartment should be made.

### **Use of the frozen food storage compartment**

The freezer temperature is controlled below  $-16^{\circ}\text{C}$ , and it is advisable to store the food for long-term preservation in the freezer compartment, but the storage duration indicated on the food packaging should be adhered to.

The freezer drawers are used to store food that needs to be frozen. Fish and meat of large block size should be cut into small pieces and packed into fresh-keeping bags before they are evenly distributed inside the freezer drawers.

### **Energy saving tips**

- Let hot foods cool to room temperature before placing in the refrigerator.
- Be sure to wrap foods properly, and wipe container dry before placing them in the refrigerator. This cuts down on frost build-up inside the refrigerator.
- Organize and label food to reduce door openings and extended searches.

### **Tips for shopping the frozen foods**

1. When you are buying frozen food, look at the Storage Guidelines on the packaging. You will be able to store each item of frozen food for the period shown against the star rating. This is usually the period stated as "Best to use them before\*", found on the front of the packaging.
2. Check the temperature of the frozen food cabinet in the shop where you buy the frozen foods.
3. Make sure the frozen food package is in perfect condition.
4. Always buy frozen products last on your shopping trip or visit to the supermarket.
5. Try to keep frozen food together whilst shopping and on the journey home, as this will help to keep the food cooler.
6. Don't buy frozen food unless you can freeze it straight away. Special insulated bags can be bought from most supermarkets and hardware shops. These keep the frozen foods cold longer.
7. For some foods, thawing before cooking is unnecessary. Vegetables and pasta can be added directly to boiling water or steam cooked. Frozen sauces and soups can be put into a saucepan and heated gently until thawed.
8. Use quality food and handle it as little as possible. When foods are frozen in small quantities, it will take less than for them to freeze up and thaw.
9. Estimate the amount of foods to be frozen up. When freezing large amounts of fresh food, adjust the temperature control panel to the low mode, with the freezer temperature lowered. So, foods can be frozen up in fast manner, with the food freshness well kept.

## **VI. Tips for special needs**

### **Moving the refrigerator/freezer**

#### **•Location**

Do not place your refrigerator/freezer near a heat source, e.g. cooker, boiler or radiator. Avoid it from direct sunlight in out-buildings or sun lounges.

#### **•Leveling**

Make sure to level your refrigerator/freezer using the front leveling feet. If not level, the refrigerator/freezer door gasket sealing performance will be affected, or even it may lead to the operating failure of your refrigerator/freezer.

After locating the refrigerator/freezer in position, wait for 4 hours before using it, so as to allow the refrigerant to settle.

#### **•Installation**

Do not cover or block the vents or grilles of your appliance.

When you are not in the RV for a long time

- If the appliance will not be used for several months, turn it off first, and then disconnected the power source.

- Take out all foods.
- Clean and dry the interior thoroughly. To prevent odor and mold growth, leave the door ajar: block it open or have the door removed if necessary.
- Keep the cleaned appliance in a dry, ventilated place and away from the heat source, place the appliance smoothly, and do not place heavy objects on top of it.
- The unit should not be accessible to child's play.

## VII. Maintenance and cleaning



**When cleaning, Do not stretch your hands into the bottom of the refrigerator, since you might be scratched by sharp metal corners.**

### Internal cleaning and external cleaning

The food residuals in the refrigerator are liable to produce bad odor, so the refrigerator must be cleaned regularly. The fresh food compartment is usually cleaned once a month.

Remove all shelves, crisper box, bottle racks, cover board, and drawers etc., and clean them with a soft towel or sponge dipped in warm water or neutral detergent.

Clear off the dusts accumulated on the rear panel and side plates of the refrigerator often.

After using detergent, be sure to rinse it with clean water, and then wipe it dry.



**Do not use bristle brush, steel wire brush, detergent, soap powder, alkaline detergent, benzene, gasoline, acid, hot water and other corrosive or soluble items to cleanse the cabinet surface, door gasket, plastic decorative parts, etc., so as to avoid damage.**

Carefully wipe dry the door gasket, clean the groove. After the cleaning, fix the four corners of the door gasket first, and then embed it segment by segment into the door groove.

Interruption of power supply or failure of the refrigerating system

- Take care of the frozen foods in the event of an extended non-running of the refrigerating appliance (such as interruption of power supply or failure of the refrigerating system).
- Try to open the refrigerator door as least as possible, this way food can safely and freshly be kept for hours even in hot summer.

### Defrosting

This appliance is designed with automatic defrosting function, thus no need to defrost it manually.

### Changing the lamp

The LED lamp is used by the refrigerator for lighting, which features low energy consumption and long service life. In case of any abnormality, please contact the after-sales personnel service.

### How to disassemble the parts.

Fridge door bottle rack:

Hold the bottle rack with both hands, and then push it up.

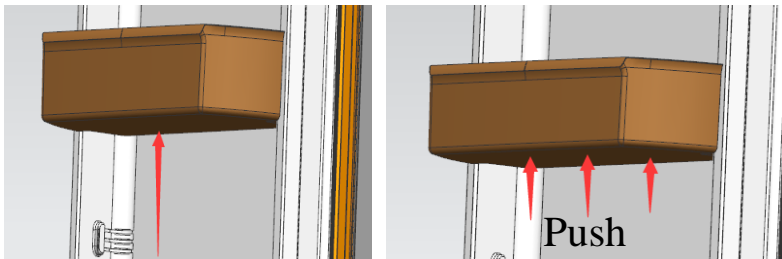

## VIII. Simple fault analysis and elimination

You can solve many common refrigerator problems easily, saving you the cost of a possible service call. Try the suggestions below to see if you can solve the problem before calling for service.

Case	Inspection	Solutions
·Completely non-refrigeration	<ul style="list-style-type: none"> <li>• Power source connected is OK?</li> <li>•Are breakers and fuses broken?</li> <li>•No electricity or line trip?</li> </ul>	<ul style="list-style-type: none"> <li>• Refer to the wiring diagram, check the power wiring connection.</li> <li>•Opening the door and checking whether the lamp is lit.</li> <li>• Check fuse</li> </ul>
·Abnormal noise	<ul style="list-style-type: none"> <li>•Is refrigerator stable?</li> <li>•Does refrigerator contact the wall?</li> </ul>	<ul style="list-style-type: none"> <li>•Adjusting refrigerator's leveling feet.</li> <li>•Off the wall.</li> </ul>
·Poor refrigerating efficiency	<ul style="list-style-type: none"> <li>•Do you put hot food or too much food?</li> <li>•Do you open the door frequently?</li> <li>•Do you clip food bag to the door gasket?</li> <li>•Direct sunlight or near a furnace or stove?</li> <li>•Is it well-ventilated?</li> <li>•Temperature setting in too high?</li> </ul>	<ul style="list-style-type: none"> <li>•Putting food into refrigerator when hot food becomes cool.</li> <li>•Checking and closing the door.</li> <li>•Removing the refrigerator from the heat source.</li> <li>•Emptying the distance to maintain good ventilation. ◦</li> <li>•Setting to the appropriate temperature.</li> </ul>
·Peculiar smell in refrigerator	<ul style="list-style-type: none"> <li>•Any spoiled food?</li> <li>•Do you need to clean refrigerator?</li> <li>•Have you packed food of strong flavors?</li> </ul>	<ul style="list-style-type: none"> <li>•Throwing away spoiled food.</li> <li>•Cleaning refrigerator.</li> <li>•Packing food of strong flavors.</li> </ul>
The light is not working;	<ul style="list-style-type: none"> <li>•Check LED light damaged?</li> <li>•Open the door too long?</li> </ul>	<ul style="list-style-type: none"> <li>•The LED light may be damaged</li> <li>•The control system has disable the lights due to the door being kept open too long, close and reopens the door to reactivate the lights.</li> </ul>

 **Note:** If the above descriptions are inapplicable to troubleshooting, do not disassemble and repair it yourself. Repairs carried out by inexperienced persons may cause injury or serious malfunctioning. Contact the local store where your purchase was made. This product should be serviced by an authorized engineer and only genuine spare parts should be used.

When the refrigerator is not in use for long periods, disconnect from the electricity supply, empty all foods and clean it, leaving the door ajar to prevent unpleasant smells.



# FURRION®

Furrion, LLC (Furrion) are wholly owned subsidiaries of Lippert Components, Inc. (Lippert)  
Furrion, LLC (Furrion) sont des filiales en propriété exclusive de Lippert Components, Inc. (Lippert)  
Furrion, LLC: 52567 Independence Ct., Elkhart, IN, 46514

Furrion Innovation Center & Institute of Technology  
Centre d'innovation et institut de technologie Furrion  
22244 Innovation Drive, Elkhart, IN 46514-5514, USA  
Toll free/Numéro gratuit/Línea telefónica gratuita: 1-800-789-3341  
Email/Courriel/Correo electrónico: [customerservice@lci1.com](mailto:customerservice@lci1.com)

©2007-2025 Furrion, LLC. All rights reserved.

©2007-2025 Furrion, LLC. Tous droits réservés.

For Patent Info: [www.Lippert.com/patents](http://www.Lippert.com/patents)

Pour des informations sur les brevets: [www.Lippert.com/patents](http://www.Lippert.com/patents)

[SUPPORT.LCI1.COM/FURRION](http://SUPPORT.LCI1.COM/FURRION)



The contents of this manual are proprietary and copyright protected by Lippert. Lippert prohibits the copying or dissemination of portions of this manual unless prior written consent from an authorized Lippert representative has been provided.

Any unauthorized use shall void any applicable warranty.

The information contained in this manual is subject to change without notice and at the sole discretion of Lippert. Revised editions are available for free download from [lippert.com](http://lippert.com).

Please recycle all obsolete materials.

Les renseignements contenus dans le présent manuel peuvent seulement être distribués sous forme de document complet, à moins de recevoir l'approbation explicite de Lippert Components pour distribuer des parties individuelles. Tous les renseignements contenus dans le présent manuel peuvent être modifiés sans préavis. Les éditions révisées pourront être téléchargées gratuitement sur le site [lci1.com](http://lci1.com). Ces renseignements sont considérés comme étant factuels jusqu'à ce qu'une version révisée les rende désuets.

Veuillez recycler tout le matériel désuet.

For all concerns or questions, please contact Lippert.

Communiquer avec Lippert Components si vous avez des questions ou des préoccupations.

Ph: 432-LIPPERT (432-547-7378) | Web: [lippert.com](http://lippert.com) | Email: [customerservice@lci1.com](mailto:customerservice@lci1.com)