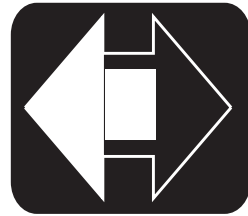



Table of Contents

	Page
Introduction	1
Operating Your Room	
Slide	2
Fault Diagnostics	3
Override Modes	4
RPE Crank Mode	5
FLS Crank Mode	6



FLS/RPE DigiSync Room Slide System

Figure 1

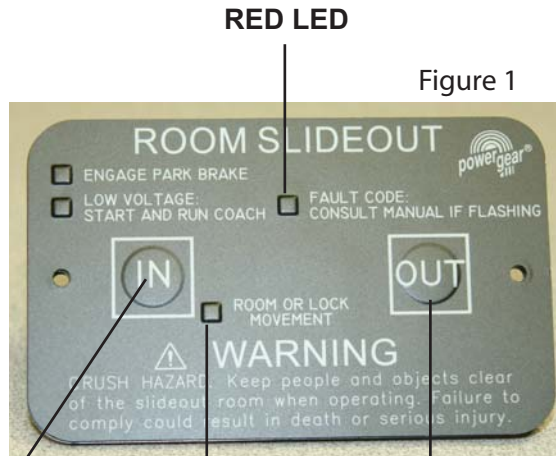

IN BUTTON GREEN LED OUT BUTTON



READ ALL OPERATING INSTRUCTIONS FIRST BEFORE USING YOUR ROOM SLIDE.

Introduction

This coach is equipped with a FLS or RPE DigiSync Room Slide Mechanism from Power Gear. DigiSync utilizes a hall effect sensor to synchronize the movement of the two arms that support the room to insure good room slide seals and smooth, even room slide operation. Additionally, DigiSync has a number of operational and trouble-shooting features that make it easy to use.

The room slide out system is made up of one or two drive arms each consisting of an inner and outer tube, which slide within one another. The load of the room is carried primarily by guide blocks or front rollers that are attached to the outer rail and rear rollers attached to the inner tube.

Depending upon which room slideout system you have, each drive arm is moved by a rack and pinion (RPE) or Acme Screw (FLS) which is driven by a 12 VDC gear motor. If two or more arms are used on a slideout room, they are synchronized using DigiSync's patented sensor programming. To prevent the room from moving during travel, a motor brake is used on the RPE systems and an acme screw is used on the FLS Systems.



Operating Your Room Slide - Operating Safety Precautions



Prior to extending the room, take a moment to insure the following:

1. Follow the coach manufacturer instructions regarding the leveling of the coach and room slide out operation.
 2. If your coach is equipped with a luggage compartment beneath the room that extends, make sure that the luggage compartment doors are closed so that they will not interfere with slide out operation.
 3. Check both inside and outside of the vehicle to make sure that there are no people who could be harmed or obstacles that could cause damage due to room extension or retraction
 4. Check to ensure that all safety travel straps / bars have been removed and that no obstructions exist between the inside wall flange and the inside wall of the coach.
 5. Park brake must be set.
- If the slide out room is equipped with a couch or other furniture, make sure that the room is clear of people and pets during extension. Once the room has reached its maximum extension the room may be occupied again.



Prior to retracting the room, take a moment to insure the following:

1. Follow the coach manufacturer instructions regarding the leveling of the coach and room slide out operation.
2. Check both inside and outside of the vehicle to make sure that there are no people who could be harmed or obstacles that could cause damage due to room extension or retraction
3. If the slide out room is equipped with a couch or other furniture, make sure that the room is clear of people and pets during retraction. Once the room has completely retracted, it may be occupied again.
4. Park Brake must be set.

To ensure ample voltage to the room slideout motors, operate your slideout room while the coach is running and the parking brake is set.

Extending Your Slide Out Room

See Operating Safety Precautions Above Before Proceeding.

To extend the room slide, simply press and hold the "OUT" button until the green "Room or Lock Movement" LED (Refer to Figure 1 on page 1) is no longer lit. To stop the room during operation, release the button. Once the room has reached its full extension it will stop automatically. The extend button will not function again until the retract button has been pressed.

Retracting Your Slide Out Room

See Operating Safety Precautions Above Before Proceeding.

To retract the room simply press and hold the "IN" button until the green "Room or Lock Movement" LED (Refer to Figure 1 on page 1) is no longer lit. To stop the room during operation, release the button. Once the room has completely retracted it will stop automatically. The retract button will not function again until the extend button has been pressed.

Fault Diagnostics

This control has the ability to detect and display several faults. When a fault is detected, the room movement will stop, and two different LEDs will flash in a pattern.

- The Red Fault Code LED (Fig 1) will flash a number of times corresponding to a specific fault code. Refer to the Troubleshooting chart below to best determine what caused the fault.
- The Green Room Movement LED (Fig 1) will flash a number of times corresponding to which slideout rail had the associated fault (or with battery Voltage faults, will flash once to signify the start/end of the flashing fault code).

For example, if you are seeing 5 red flashes and 2 green flashes, it means there is no signal on the sensor wire on motor 2.

There are 2 types of faults (Minor and Major) and a fault must be cleared in order for the room to operate. Prior to clearing the fault, write down the number of flashes that you are seeing in the table below. This information will help your dealer/ service center in the troubleshooting of the slideout system.

# of RED flashes	# of GREEN flashes

- MINOR faults can be cleared by pushing and releasing the IN or OUT buttons on the wall touch pad.
- MAJOR faults must be cleared by pushing and releasing the Set Stops/Clear Faults button located on the back of the wall touchpad (Fig 2). This is done to alert the user that there is a major problem with the system and to prevent damage to the slideout room.
- NOTE:** For major faults, the control must be overridden by following the Manual Mode in the Override Modes section of this manual. Once the room is retracted, take your unit to an authorized dealer for service.

NOTICE

Fault codes 5 & 7 are not used on smaller single rail slideout room applications (ie. Bedroom Slides).

Fault Code	Fault Type	Description	Probable Cause	Possible Solutions
3	Minor	Slideout Motor Short	Shorted wiring or motor	Inspect motor harness wires and motor for shorts. Replace shorted component.
4	Minor	Slideout Motor Open	Bad connection, motor, or blown fuse	Repair bad wire connection, replace motor or fuse.
5	Major (Control with Rev OF and prior) Minor (Control with Rev OG and after)	No signal on sensor wire	Bad wire connection or sensor Low Voltage state of battery	Repair bad wire connection or replace motor Start Coach engine prior to room slideout operation.
6	Minor	Excessive Battery Voltage (above 18V when room movement is requested)	Bad Battery	Repair battery
7	Major (Control with Rev OD and prior) Minor (Control with Rev OE and after)	Rail did not re-sync with opposing rail	Excessive system/ room drag, obstruction, improper stop locations, or damaged component.	Remove obstruction, re-adjust room, reset stops, or replace damaged component. control with Rev OE or prior: Keep IN or OUT button on touchpad depressed until green "room or Lock Movement" LED is no longer lit. Refer to Extending or Retracting Your Slideout Room section on page 2 for proper room operation.

NOTICE

Manual Mode and corresponding Actuator 1 & 2 locations:

Rear Actuator: Retract / In Button

Front Actuator: Extend / Out

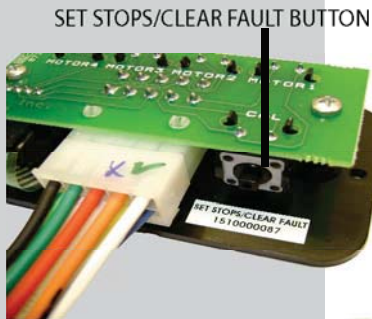

Figure 2

Override Modes

There are 2 modes to override the room slideout system.

- The first mode is the **Manual Mode** which is the easiest mode to use, however, this mode can only be used if there is not a motor failure.
- The second mode is the **Crank Mode** which should be used as a last resort if the previous mode does not work, as this means the room must be manually cranked.

1. Manual Mode

Manual mode permits the operator to individually move the two room arms by pressing the IN and OUT buttons on the touch pad. **This mode can be used only if there is not a motor failure.** To override the sensor and enter the Manual Mode, press and hold the Set Stops/Clear Fault Button (see figure 2) for approximately 5 seconds until the two upper left-hand red LEDs (Park Brake and Low Voltage) begin to flash.

While in Manual Mode each of the two room slide arms are activated by pressing and holding the IN and OUT buttons. One button will retract the front arm. The other will retract the back arm. Both IN and OUT buttons may be held down at the same time to simultaneously activate both arms to retract the room. If one side of the room gets ahead of the other, release that button until the other arm catches up. The current limiting feature of the control still functions in the Manual Mode so each side can be fully retracted until it stops.

Once the room has been retracted the control will return to the automatic mode after 60 seconds. You can manually return to automatic mode by pressing and holding the Set Stops/Clear Faults button for approximately 1 second, then releasing when the two upper left-hand red LED's (Park Brake and Low Voltage) stop flashing.

2. Crank Mode

Use the below procedures to manually crank your room in when you have a motor failure.

The procedures below are for 2 different types of room slideout systems. You must first determine what type of rail assembly you need to override. The two types are RPE (rack and pinion) or FLS (acme screw).

Figure 5

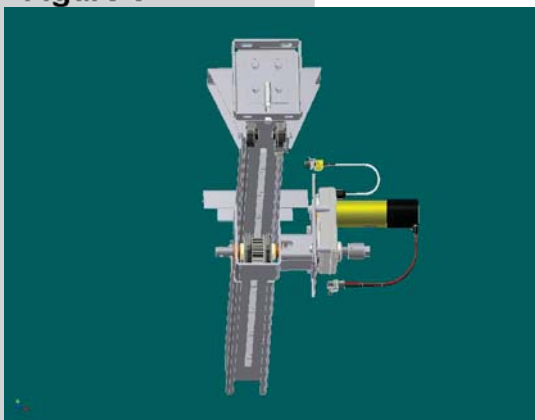

RPE Crank Mode

Use this procedure only with a rack and pinion rail assembly. Refer to Figure 5. In the event of a total system failure, a 3/4" socket or wrench may be used to retract or extend the room.

Your Power Gear slide out system is equipped with a manual override that allows you to extend or retract the room in the event of a loss of power.

If the room does not extend when the switch is pressed, check the following:

1. Battery is fully charged and connected.
2. All system fuses/circuit breakers are good.

Override Modes, cont'd...

If, upon checking the previous items, the room still does not extend, follow this override procedure:

1. Check the slide out awning (some awnings must be manually unlocked before operating).

2. Locate the slide out motor (Figure 4). The motor is attached to the rail assembly inside the storage compartment under the slide out room. Some rooms may have multiple motors.

3. Unplug the 2-pin motor lead. This will make overriding your room easier.

4. With your thumb, depress the spring lock lever on the right hand side of the boot cover. Then, rotate the override lever counter clockwise with your index finger to disengage the motor brake. Refer to figure Figure 3 at left.

5. Locate the manual override on the end of the motor.

6. Using a 3/4" wrench or ratchet, crank the room either in or out completely (depending on your need). You will need to alternate between each slideout rail with a motor to move the room in or out. If help is available, a second person operating an additional crank on the second motor will accelerate the process.

7. When the room is fully in/out, apply pressure to the wrench or ratchet and return the motor brake lever to the "Engaged" position. This will ensure the room is locked into a sealed position.

8. Plug the motor leads back in.

9. Check the slide out awning (some awnings must be manually locked before traveling).

10. Take the unit to an authorized dealer for service.

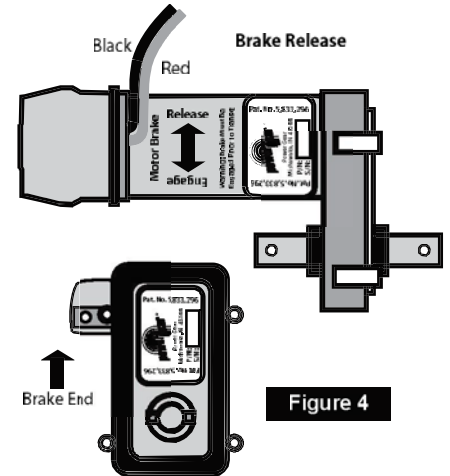

Figure 4

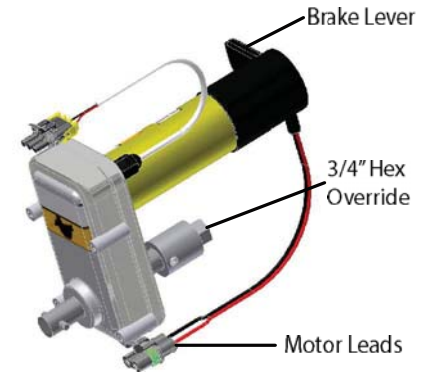

Figure 3



NOTICE

When the motor brake is disengaged the slide out room will not lock in place. Therefore, the room will not be sealed. When the room has been manually retracted, return the brake lever to its normal "Engaged" position in order to seal and lock the room into position.

NOTICE

Improper use of the crank handle can result in damage to your slideout system. Crank mode should only be used to retract your slideout in the event of a system failure.

FLS Crank Mode

Use this procedure only with an acme screw rail assembly (Refer to Figure 6). In the event of total system failure, 1 or 2 crank handles may be used to retract room.

To use the crank handles, either open the luggage compartment doors, or remove the cover on units without StoreMore, exposing the front of each room slide mechanism. Insert the crank handle (Figure 6 and 7) into the tube and align the drive pin at the rear of the tube with the notches in the crank handle. It may be necessary to move the handle slightly from side to side. The crank handle will only move the tube that it is inserted into. Consequently you will need to alternate between each crank handle on each side to move the room in. If help is available, a second person cranking on the other handle simultaneously will greatly speed up the process for a two arm system.

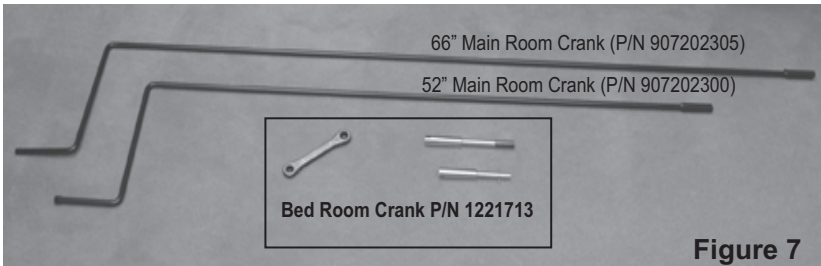
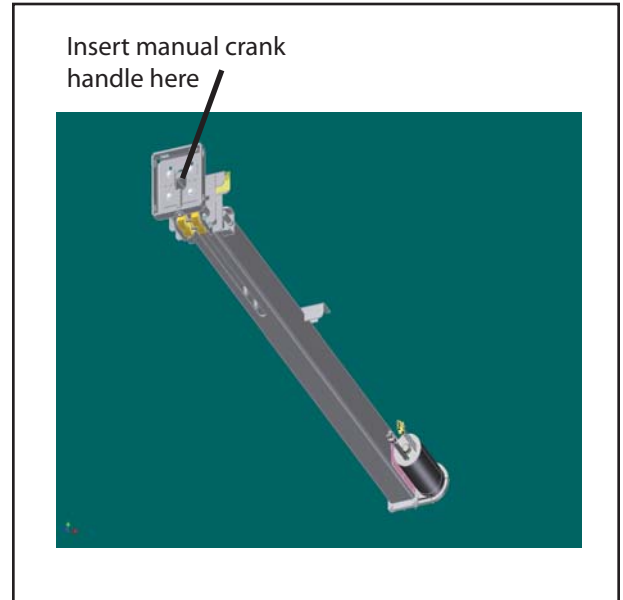

Figure 7



Additional Reference Documents Located at powergearus.com:

- 82-SO505 - Manual Retraction of Slideout
- 82-SO506 - Proper Engagement & Testing of Motor Break on Power Gear Slideout System
- 82-SO513 - Slideout System Fault Code Information
- 82-SO517 - Encoder Test 1 FLS/RPE Controllers: 1510000151, 1510000152 and 1510000180
- 82-SO520 - Encoder Test 2 FLS/RPE Controllers: 1510000151, 1510000152, 1510000180
- 82-SO516 - FLS/RPE DigiSync Room Slide System Manual Service Bulletin