



**ABOVE FLOOR SLIDE-OUT
OWNER'S MANUAL**

L I P P E R T
C O M P O N E N T S[®]

TABLE OF CONTENTS

Warning, Safety, and System Requirement Information	3
Product Information	3
Prior to Operation	3
Operation	3
Extending Slide-out Room.....	4
Retracting Slide-out Room.....	4
Maintenance	4
Preventative.....	4
Electric.....	4
Mechanical Maintenance.....	5
Troubleshooting	5
Troubleshooting Introduction.....	5
Switch Related Problems.....	5
Motor Unit.....	5
Manual Override.....	7
Room Adjustment.....	8
Above Floor Sofa Slide-out Assembly (Dual Rail)	9
Above Floor Sofa Slide-out Components (Dual Rail)	10-12
Notes	13

Warning, Safety, and System Requirement Information

WARNING

Failure to act in accordance with the following may result in death, serious injury, coach or property damage.

The Lippert Above Floor Slide-out System is intended for the sole purpose of extending and retracting the slide-out room. Its function should not be used for any other purpose or reason than to actuate the slide-out room. To use the system for any reason other than what it is designed for may result in damage to the coach and/or cause serious injury or even death.

Before actuating the system, please keep these things in mind:

1. Parking locations should be clear of obstructions that may cause damage when the slide-out room is actuated.
2. Be sure all persons are clear of the coach prior to the slide-out room actuation.
3. Keep hands and other body parts away from slide-out mechanisms during actuation. Severe injury or death may result.
4. To optimize slideout actuation, park coach on solid and level ground.

Product Information

The Lippert Above Floor Slide-out System is a rack and pinion style slide system. Utilizing a bi-directional electric motor to actuate the drive shaft, the slide-out room is extended and retracted from the same source. The actuator has a built-in automatic braking feature. The Lippert Above Floor Slide-out is designed as a negative or positive ground system.

There are no serviceable parts within the electric motor. If the motor fails, it must be replaced.

Disassembly of the motor voids the warranty.

Mechanical portions of the slide-out system are replaceable. Contact Lippert Components, Inc. to obtain replacement parts.

Prior to Operation

Prior to operating the Lippert Above Floor Slide-out, follow these four (4) guidelines:

1. Coach should be parked on the most level surface available.
2. The PARKING BRAKE must be engaged.
3. The coach's transmission must be in PARK.
4. The coach's ignition must be in the ON or RUN position or the coach's engine must be running. (Class A and C only; Gas and Diesel)

Operation

WARNING

Failure to act in accordance with the following may result in death, serious injury, coach or property damage.

Always make sure that the slide-out room path is clear of people and objects before and during operation of the slide-out room.

Always keep away from the slide rails when the room is being operated. The gear assembly may pinch or catch on loose clothing causing personal injury.

Keep stored items in compartment clear of slide-out motor mechanisms and wiring to prevent interference of slide-out operation.

Install transit bars (if so equipped) on the slide-out room during storage and transportation.

The family of Lippert Above Floor Slide is controlled by a switch mounted on the coach wall, normally located close to the entry door.

Extending Slide-out Room

1. Level Unit.
2. Verify the battery is fully charged and hooked up to the electrical system.
3. Remove transit bars (if so equipped).
4. Press and hold the IN/OUT switch in the OUT position until room is fully extended and stops moving.
5. Release switch, which will lock the room into position.

NOTE: Only hold OUT switch until room stops.

Retracting Slide-out Room

1. Verify the battery is fully charged and hooked up to the electrical system.
2. Press and hold the IN/OUT switch in the IN position until the room is fully retracted and stops moving.
3. Release the switch. This will lock the room into position.

NOTE: Only hold IN switch until room stops.

4. Install the transit bars (if so equipped).

Maintenance

Preventative

The Lippert Above Floor Slide-out has been designed to require very little maintenance and has been static tested to over 2,500 continuous cycles with out any noticeable wear to rotating or sliding parts. No grease or lubrication is necessary and in some situations may be detrimental to the environment and long term dependability of the system. To ensure the long life of your slide-out system, read and follow these few simple procedures.

Electric

For optimum performance, slide-out system requires full battery current and voltage. The battery must be maintained at full capacity. Other than good battery maintenance, check the terminals and other connections at the battery, the control switch, and the electric motor for corrosion, and loose or damaged terminals. Check motor leads under the motor-home chassis. Since these connections are subject to damage from road debris, be sure they are in good condition.

NOTE: The Lippert Above Floor Slide-out is designed to operate as a negative ground system. A 12V DC system must maintain good wire connections. It is important that the electrical components have good ground connection. Over 90% of unit electrical problems are due to bad ground connections.

Mechanical Maintenance

Although the system is designed to be almost maintenance free, inspect the slide-out for any visible signs of external damage after and before movement of the room. Remember to inspect inside the coach as well as the slide-out outside the coach.

NOTE: For long-term storage, it is recommended that the room be closed (retracted).

NOTE: Visually inspect the Slide Floor and Drive Box Assemblies. Refer to Fig. 1 for location of rail assemblies. Check for excess build-up of dirt or other foreign material; remove any debris that may be present.

NOTE: If the system squeaks or makes any noises it is permissible to apply a coat of lightweight oil to the drive shaft and roller areas but remove any excess oil so dirt and debris do not build-up. DO NOT use grease.

Troubleshooting

Troubleshooting Introduction

The Lippert Above Floor Slide-out System is only one of four inter-related slide-out room system components. These four components are as follows: Chassis, Slide-out room, Coach and Lippert Above Floor Slide-out System. Each one needs to function correctly with the others or misalignment problems will occur.

Every coach has its own personality and what may work to fix one coach may not work on another, even if the symptoms appear to be the same.

When something restricts room travel, system performances will be unpredictable. It is very important that slide rails, rack and pinion be free of contamination and allowed to travel freely the full distance or "STROKE." Debris build-up during travel is an example of the type of contamination that may occur.

When beginning to troubleshoot the system, make sure the battery is fully charged, there are no visible signs of external damage to the actuator, motor or rails and that the motor is wired properly and all connections are secure.

You can adjust room extension by modifying the position of the rack gear on the slide floor rail to the pinion gear on the gear assembly.

During troubleshooting, remember, by changing, altering or adjusting one thing, it may affect something else. Be sure any changes do not create a new problem.

Switch Related Problems

- If room moves opposite from what the switch plate indicates, reverse the motor wires on the back of the switch. Wire size must be 10ga. min.
- If a gear is stripped, the entire gearbox must be replaced.

Motor Unit

Before attempting to troubleshoot the Power Unit, make sure an adequate power source is available. The unit batteries should be fully charged or the unit should be plugged into A/C service with batteries installed. Do not attempt to troubleshoot the Power Unit without assuring a full 12V DC charge.

The following tests require only a DC voltmeter (or DC test light) and a jumper lead.

Step 1 - Attach voltmeter (or test light) leads to the negative and positive switch terminals on back of wall switch. Does the meter indicate 12VDC?

If **YES**, see **Step 2**; if **NO** see **Step 3**.

Step 2 - If **YES**, at the motor, check the incoming leads to 12V DC (if necessary, disconnect leads at wire splices). Does meter indicate 12V DC? If **YES**, Power Unit needs to be replaced. The motor is not field serviceable. DO NOT ATTEMPT TO REPAIR. If **NO**, Inspect all wires and connections between the wall switch and the motor. Repair connections as necessary. Recheck as in **Step 1**.

Step 3 - If **NO**, Inspect all connections between battery and switch. Inspect any and all breakers, relays and fuses. Recheck as above in **Step 1**.

Since there are no field serviceable parts in the motor of the 12V DC motor, electrical troubleshooting and service is limited to replacing only those components as previously outlined.

NOTE: Thorough inspection of wiring and connections is the only other electrical service that can be performed.

What Is Happening?	Why?	What Should Be Done?
Room doesn't move when switch is pressed	Restriction or obstruction inside or outside of unit	Check for and clear obstruction
	Low battery voltage, blown fuse, defective wiring	Check battery voltage and charge if needed. Find and check fuse, replace if blown. Check battery terminals and wiring. Look for loose, disconnected or corroded connectors.
	Excessive room drag	Check that transit bars are removed
Power unit runs but room does not move	Motor turns, room does not move	Gear key is broken or lost. Replace gear drive assembly
	Broken gear on drive shaft	Replace gear drive assembly
	Broken gear in gearbox	Replace motor/gearbox assembly
	Bad motor or gearbox	Replace motor/gearbox assembly
Power unit runs but room moves slowly	Low battery, poor ground, extremely low outdoor temperature	Charge battery and check ground wire
	Room is in a bind	Adjust to proper room setting
	Incorrect height adjustment	Check for proper room height
Room starts to move and stops	Low battery voltage, blown fuse, defective wiring	Check battery voltage and charge if needed. Find and check fuse, replace if blown. Check battery terminals and wiring. Look for loose, disconnected or corroded connectors.
	Obstruction of room inside or outside	Check for and clear obstruction
Room chatters during operation	Teeth on gear drive broken or worn	Replace gear drive assembly
	Teeth on inner rail broken and worn	Replace inner rail assembly

⚠ CAUTION

Always disconnect battery from system prior to manually operating system. Failure to disconnect battery can cause electricity to back feed through the motor and cause serious damage to the system as well as void the warranty.

1. Accessing Out-Stop Assembly (Fig. 1).

NOTE: The slide-out out-stop assembly will be accessible from the inside of the unit. The slide-out motor and mechanism is accessible from the outside.

NOTE: The gears can be stripped out if the room is manually retracted/extended to its fullest extent and the operator continues to rotate manual override. Any damage due to misuse of the Manual Override feature will disqualify any and all claims to the limited warranty.

Fig. 1



Fig. 2

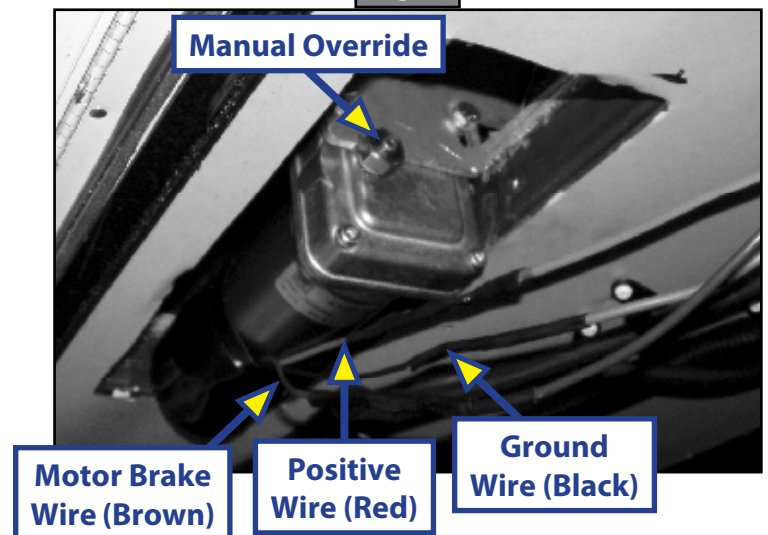

2. With a second person assisting, one person must push and hold the manual override switch while the other person, using a $\frac{5}{8}$ " wrench or socket/ratchet combination, rotates the hex head manual override (Figs. 3 and 4) to manually move the slide-out.

Fig. 3

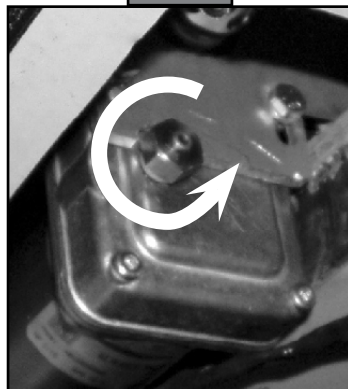
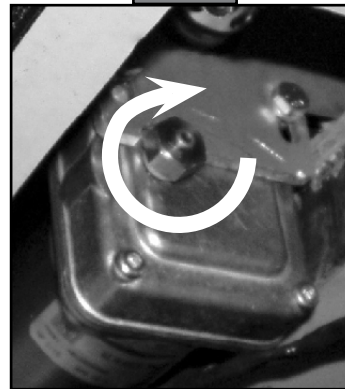
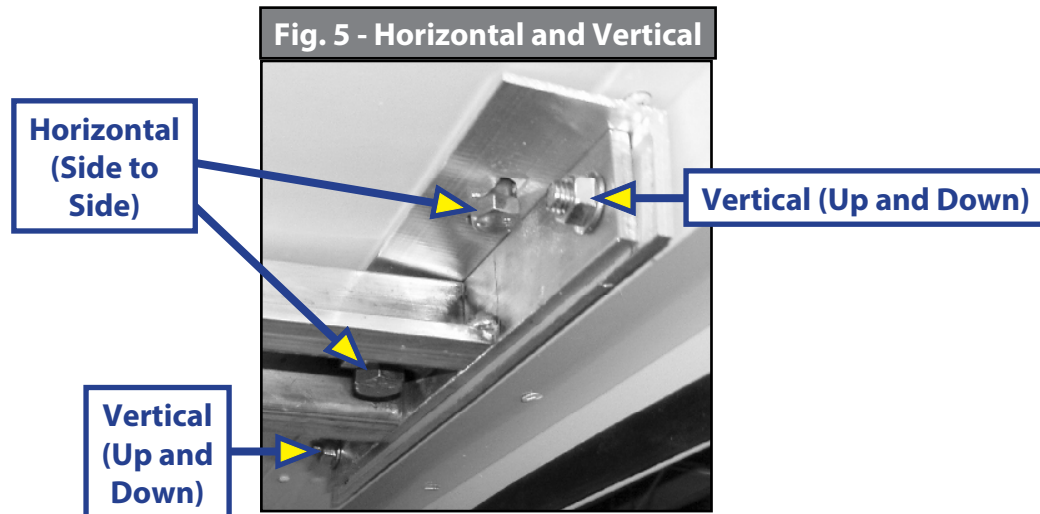

Fig. 4



Room Adjustment

1. For Horizontal Adjustment, back both lag bolts out just enough to release tension. In a Dual System, lag bolts must be loosened on both head stocks to adjust the room horizontally.
2. Adjust room to desired location.
3. Tighten lag bolts before operating room.



4. For One Stop Adjustment, loosen jam nut (shown) on the outside of the Out Stop Bracket.
5. Adjust Stop Bolt to desired location.
6. Tighten jam nut.

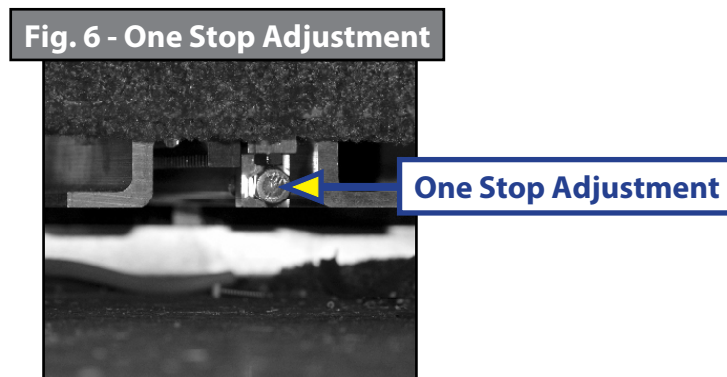



ABOVE FLOOR SOFA SLIDE-OUT ASSEMBLY (DUAL RAIL)

SLIDE-OUTS

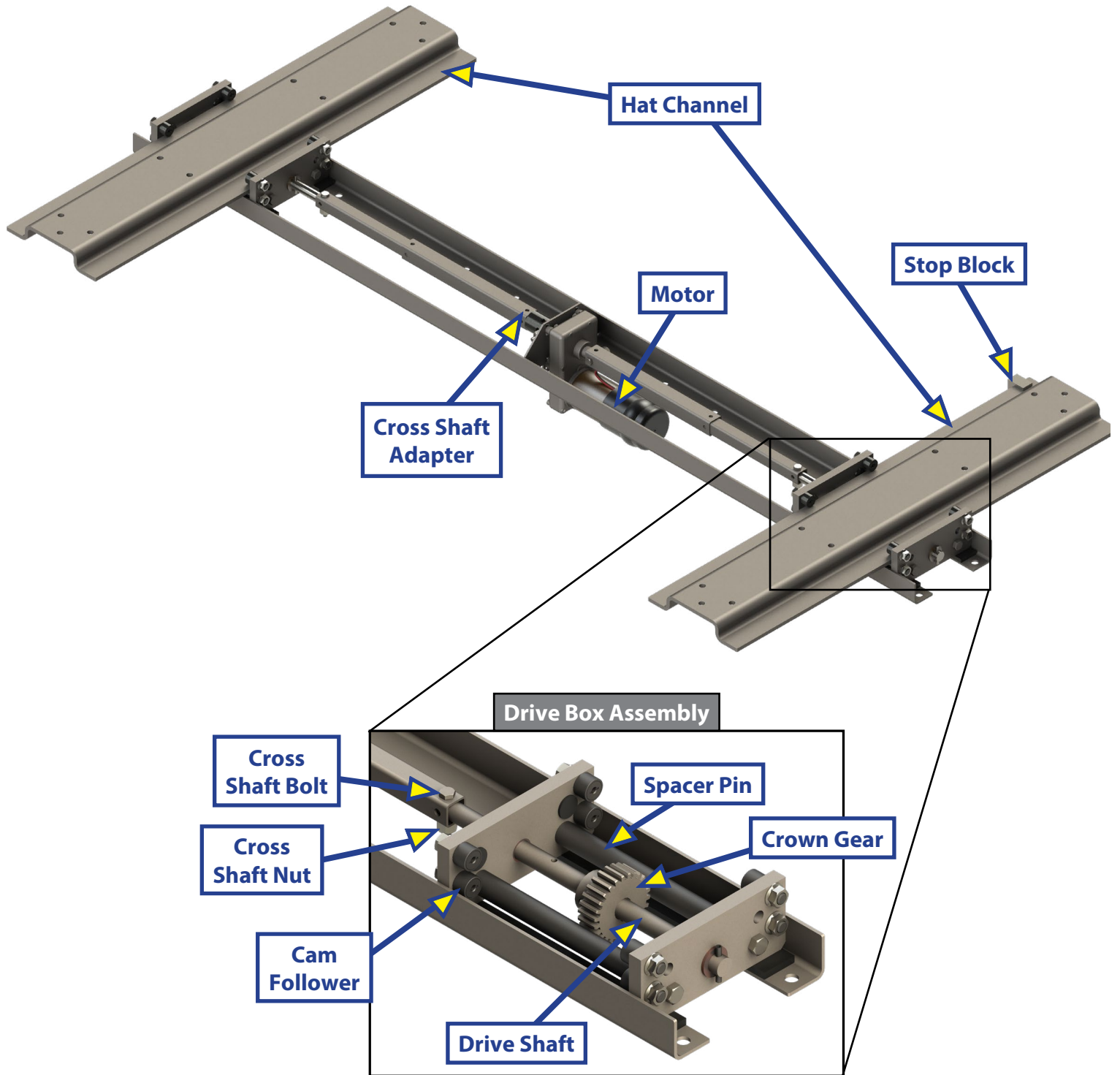



ABOVE FLOOR SOFA SLIDE-OUT COMPONENTS (DUAL RAIL)

LIPPERT
COMPONENTS

SLIDE-OUTS

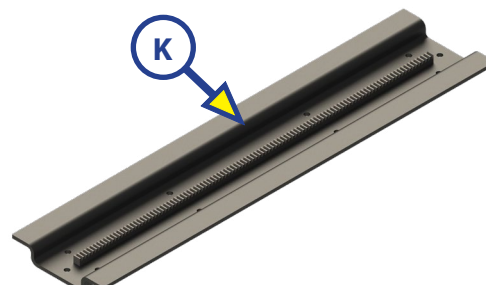
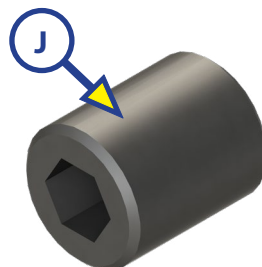
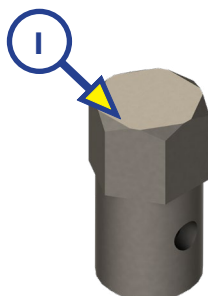
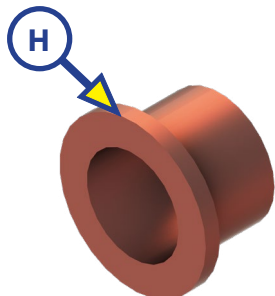
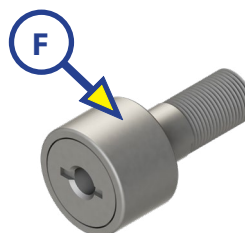
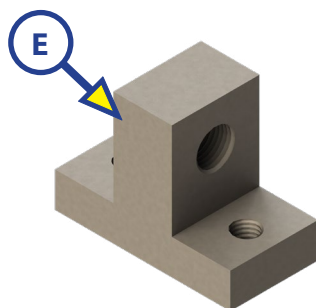
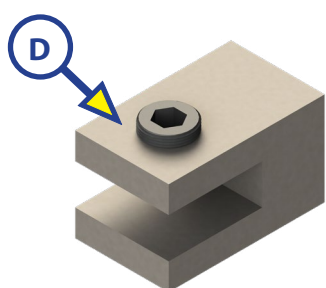
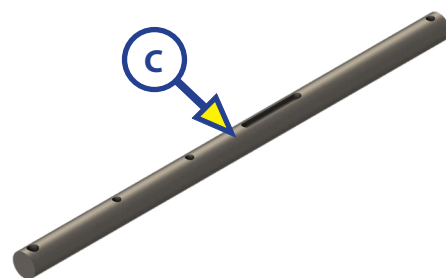
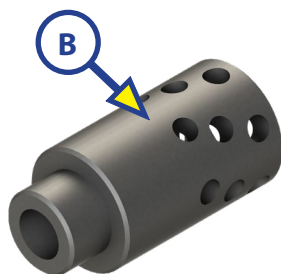
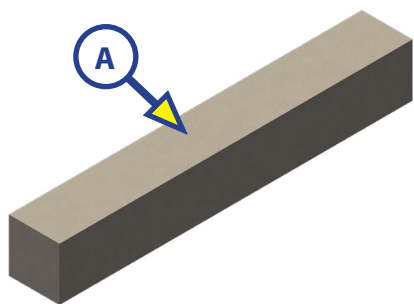

Callout	Part #	Description
A	124366	Key
B	101232	Cross Shaft Adapter
C	116656	Drive Shaft
D	124188	Stop Block with Set Screw
E	126158	Stop Block
F	118353	Cam Follower
G	116658	Crown Gear (26 Teeth)
H	116551	Bronze Bushing
I	116597	Manual Override Nut
J	125554	Crown Gear Set Screw (2x)
K	*113457	Hat Channel MF Style

NOTE: (*) To order the correct hat channel for your system, contact the LCI Parts department.



LIPPERT
COMPONENTS

ABOVE FLOOR SOFA SLIDE-OUT COMPONENTS (DUAL RAIL)

SLIDE-OUTS

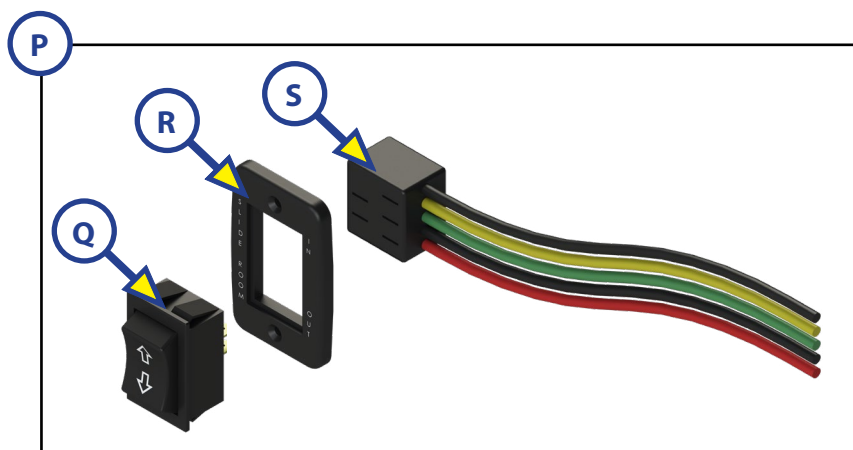
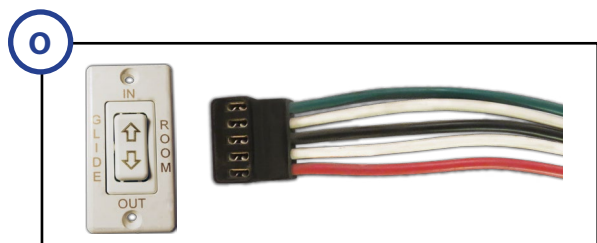
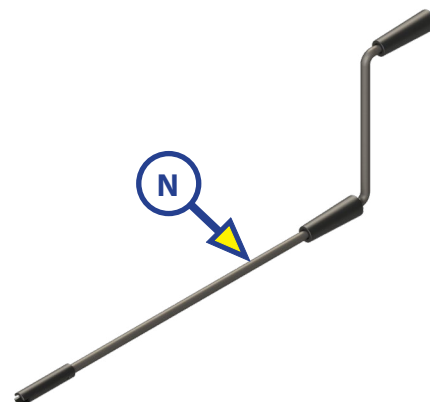
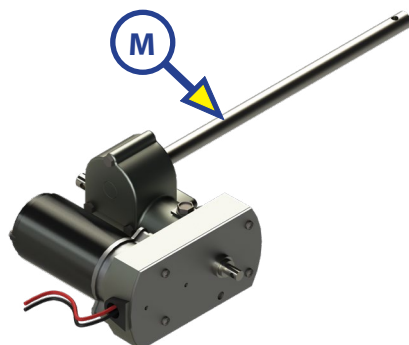
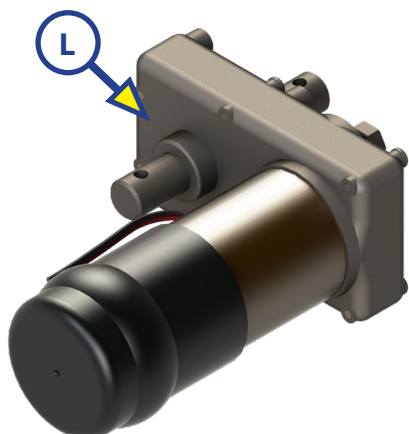

Callout	Part #	Description
L	141425	Klauber M500 Motor
M	117292	Venture 18:1 Dual Motor/Drive Shaft
	117293	Venture 28:1 Dual Motor/Drive Shaft
N	119226	Crank Handle
O	173628	Original Slide-Out Switch Kit (Obsolete)
	119134	Switch Plate (Obsolete)
	119132	Switch (Obsolete)
	119130	Switch Wire Harness (Obsolete)
P	117460	Current Slide-Out Switch Kit (Black)
	117461	Current Slide-Out Switch Kit (White)
Q	117426	Switch (Black)
	129003	Switch (White)
R	117419	Switch Plate (Black)
	117420	Switch Plate (White)
S	178436	Switch Wire Harness



LIPPERT
COMPONENTS

ABOVE FLOOR SOFA SLIDE-OUT COMPONENTS (DUAL RAIL)

SLIDE-OUTS

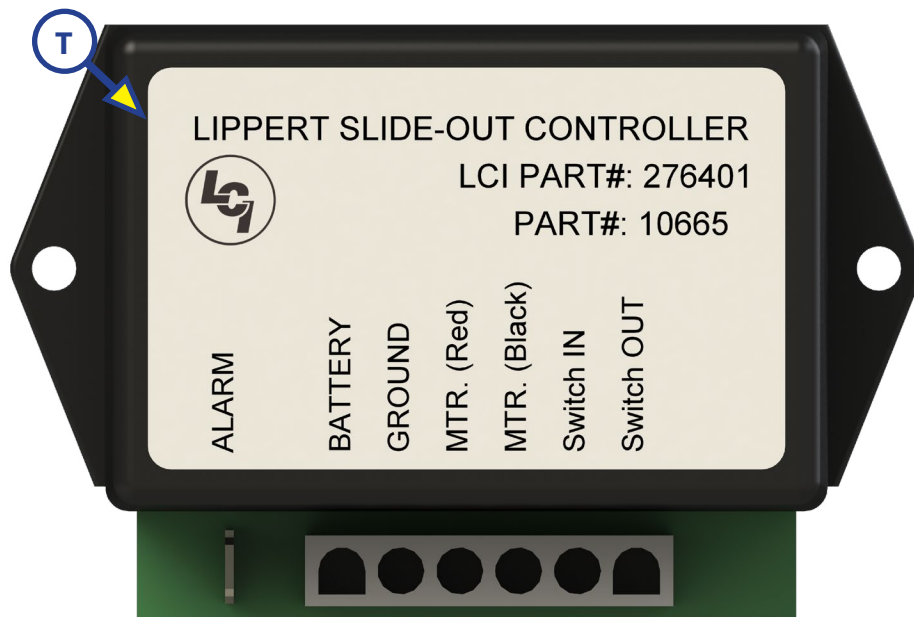

Callout	Part #	Description
T	276401	Slide-Out Controller; 30 Percent Lower



L I P P E R T C O M P O N E N T S™

The contents of this manual are proprietary and copyright protected by Lippert Components, Inc. ("LCI"). LCI prohibits the copying or dissemination of portions of this manual unless prior written consent from an authorized LCI representative has been provided. Any unauthorized use shall void any applicable warranty. The information contained in this manual is subject to change without notice and at the sole discretion of LCI.

Revised editions are available for free download from lci.com.

Please recycle all obsolete materials.

For all concerns or questions, please contact

Lippert Components, Inc.

Ph: (574) 537-8900 | Web: lci.com | Email: customerservice@lci.com