



Use this guide to determine minimum number of bolts for the applicable Pin Box.

Any 5th Wheel under 18K GVWR **MUST** use a minimum of four bolts per side.
All 5th Wheels 18K GVWR and up **MUST** use a minimum of five bolts per side.







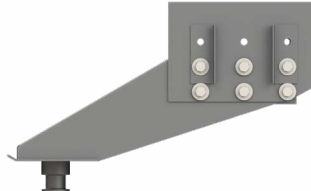
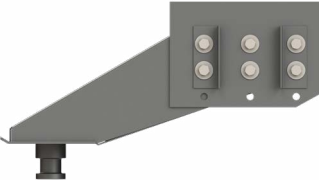
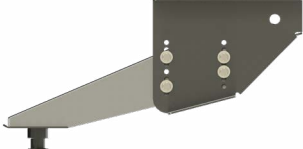
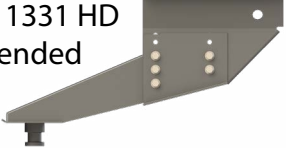
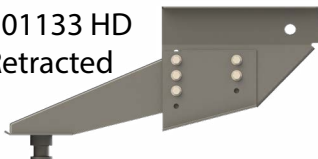
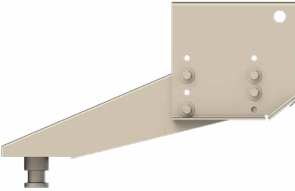
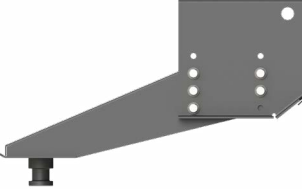

NOTE: The exception is the 1116 and 1716, which both use six bolts per side.

CAUTION

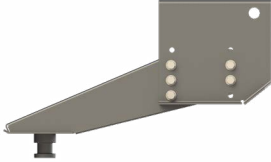
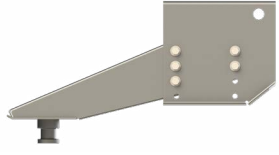
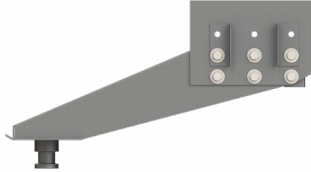
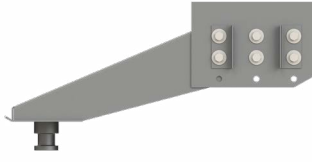

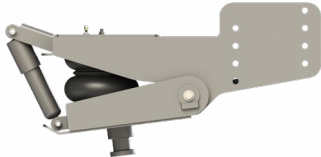

Ratings for 5th Wheels do not change unless the retail customer attaches a Pin Box that is rated lower than the GVWR listed on the towable's federal placard. This is strongly discouraged and not recommended by LCI.

<p>1116</p>	<p>19K 119118 Extended</p> 	<p>19K 1270271 Retracted</p> 
<p>1621</p>	<p>15.5K 1191191 Extended (mounted in 3rd hole down) 127026 Retracted (mounted in 2nd hole down) 152551 Fully Retracted (mounted top holes) 257619 Fully Extended (mounted in 4th hole down)</p> 	<p>18K 3011331 HD Extended</p>  <p>18K 301133 HD Retracted</p> 
<p>1621</p>	<p>15.5K 350082 Extended</p> 	<p>18K 1191151 1621 HD Extended</p> 



<p>1621</p>	<p>21K 1387883 SHD Extended</p> 	<p>21K 138788 SHD Retracted</p> 	<p>21K 248136 SHD Extended</p> 	<p>21K 2481361 SHD Retracted</p> 
<p>1716</p>	<p>15.5K 1191201 Extended</p> 	<p>15.5K 1324791 Retracted</p> 		
<p>1621 1716</p>	<p>18K 328330 1621 Rota-Flex</p> 	<p>19K 176440 1716 Rota-Flex</p> 	<p>21K 328329 1621 Rota-Flex</p> 	
<p>1621 M15</p>	<p>16K 171200 1621 LO5 T/A</p>  <p>OBSOLETE Replaced by 158778</p>	<p>18K 155930 1621 LO5 T/A</p>  <p>OBSOLETE Replaced by 158778</p>	<p>21K 158778 1621 Long Jaw LO5 T/A</p>  <p>23K 256761 M15 LO5 T/A</p> 	

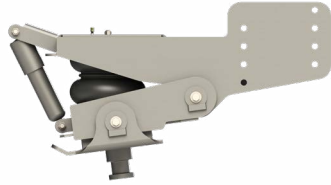

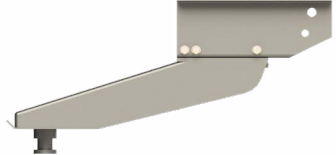
<p>1716</p>	<p>21K 158777 1716 Long Jaw LO7 T/A</p> 
<p>1621</p>	<p>18K 194170 1621 LO5 T/A Tri-Glide</p> 
<p>1716</p>	<div style="display: flex; flex-wrap: wrap;"> <div style="width: 50%;"> <p>21K 229669 1716 LO7 T/A Tri-Glide</p>  </div> <div style="width: 50%;"> <p>18K 328484 LO5 Medium Jaw T/A Flex-Air</p>  </div> <div style="width: 50%;"> <p>18K 328492 LO5 Long Jaw T/A Flex-Air</p>  </div> <div style="width: 50%;"> <p>10K 232275 Cequent Revolution</p>  </div> <div style="width: 50%;"> <p>16K 260806 Cequent Revolution</p>  </div> </div>

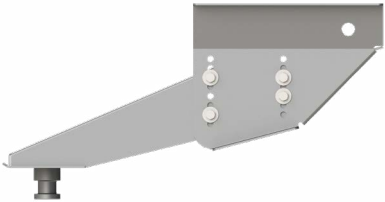
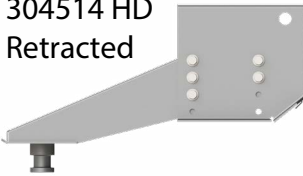
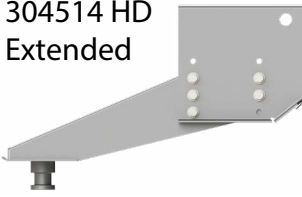
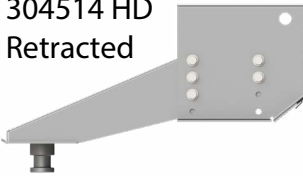
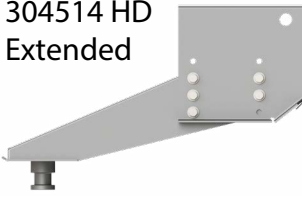
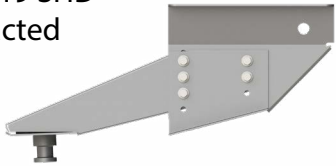
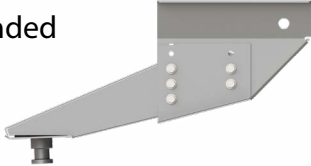
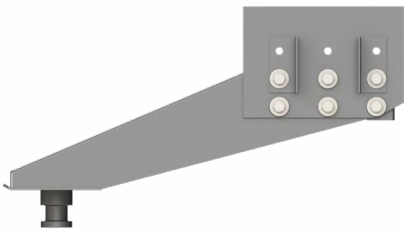
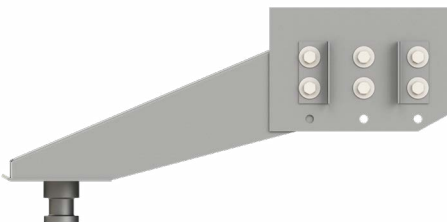
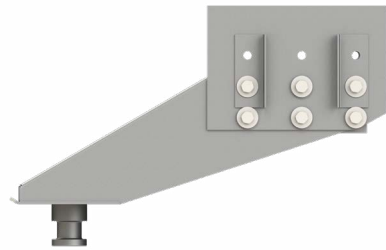
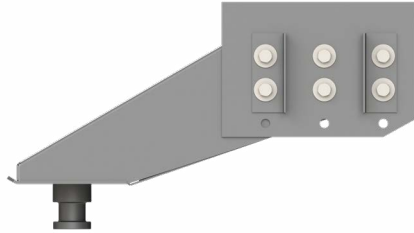

<p>1621</p>	<p>15.5K 304513 Extended (Mounted in 3rd Hole Down) 304522 Extended (Mounted in Bottom Holes) 306513 Fully Retracted (Mounted in Top Holes)</p>    <p>18K 304514 HD Retracted</p>  <p>18K 304514 HD Extended</p>  <p>21K 304519 SHD Retracted</p>  <p>21K 3045191 SHD Extended</p> 
<p>1716</p>	<p>18K 304516 1716 Retracted</p>  <p>18K 304515 1716 Extended</p> 
<p>1116</p>	<p>18K 304521 1116 Extended</p>  <p>18K 304517 1116 Retracted</p> 



Nar-Long

16K
304520 Narrow-Long

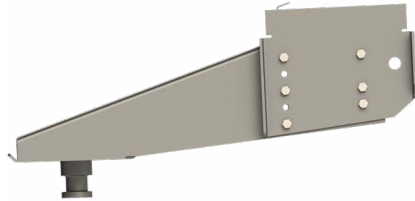

Revolution

10K
361556 Revolution

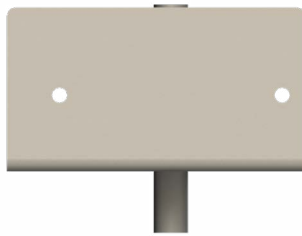

1621
15.5K
[102975/102977](#)

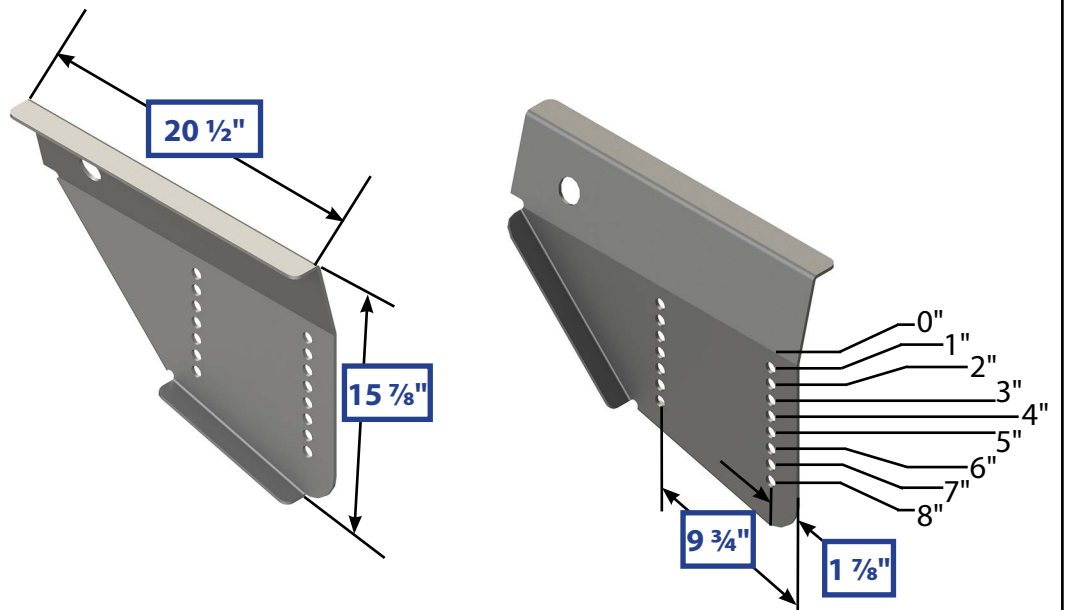



SHD 1621
M15
15.5K
126499/126503

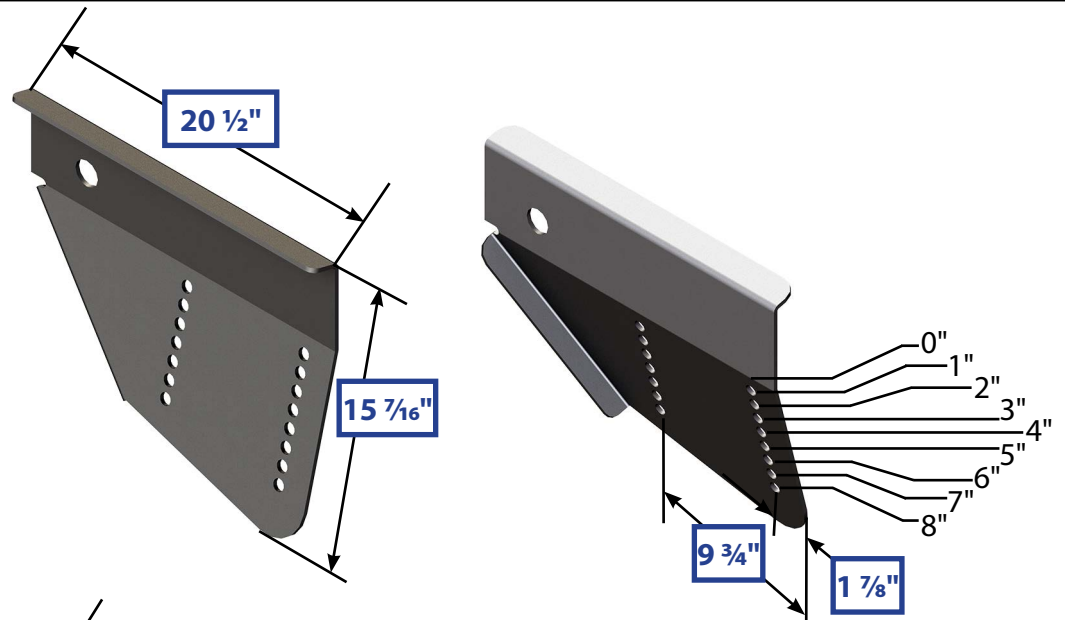

HD 1621
18K
113589/113590

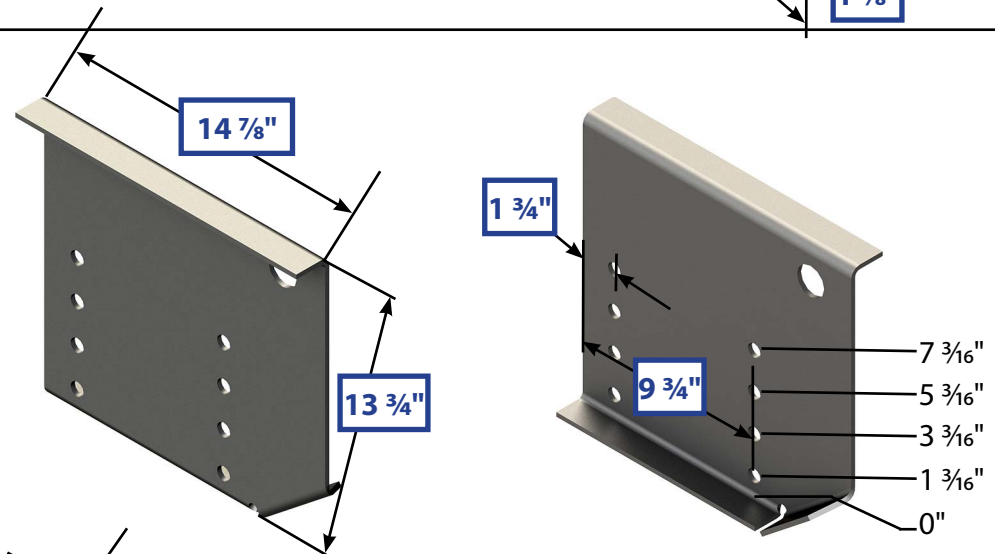



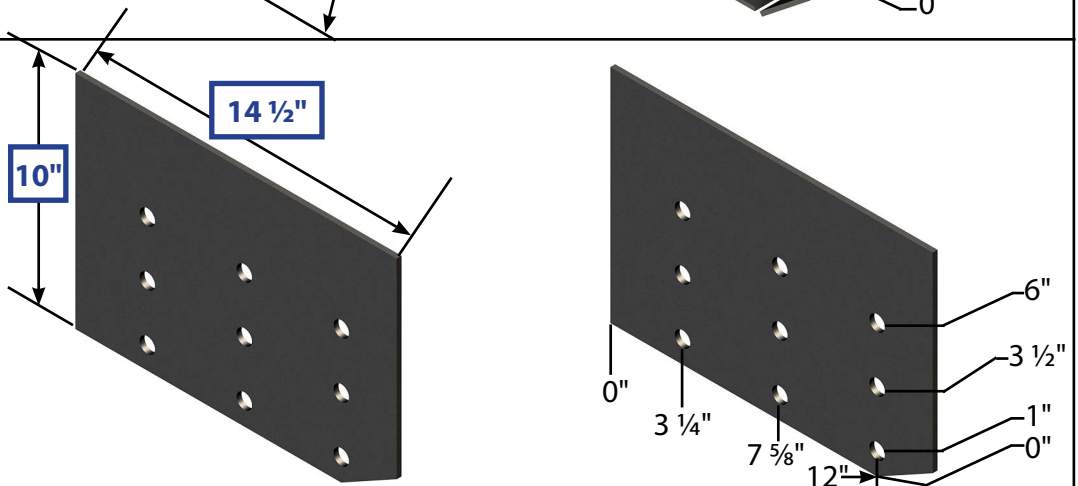

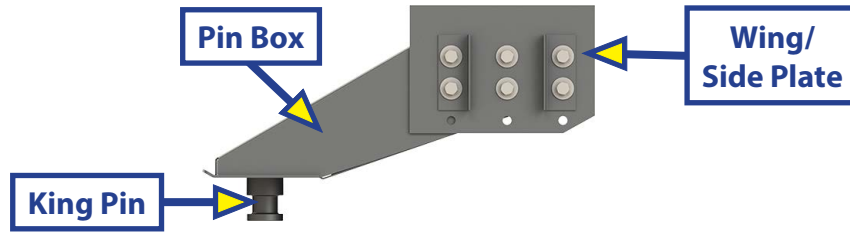
1716
1116
102964



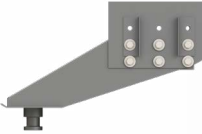
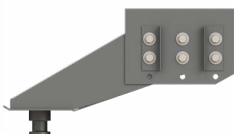

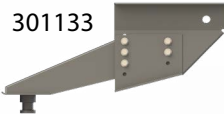
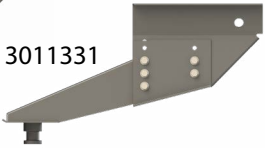
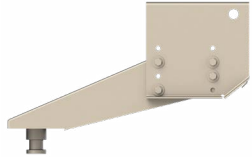
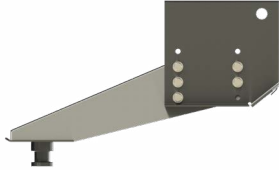
Pin Box Mounting Bolts Required per Side

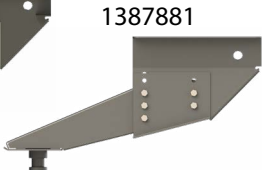
Pin Box	GVWR	Side Plate	Bolts Required per Side	Component Image
1116	19K	119118 Extended 1270271 Retracted	6	 
1621	15.5K	1191191 Extended (mounted 3rd hole down) 127026 Retracted (mounted 2nd hole down) 152551 Fully Retracted (mounted top holes) 257619 Fully Extended (mounted 4th hole down)	4	
	18K	301133 HD Retracted 3011331 HD Extended	5	 
1621	15.5K	350082 Extended	4	
	18K	1191151 HD Extended	5	
1621	21K	1387883 SHD Retracted 1387881 SHD Extended	5	 







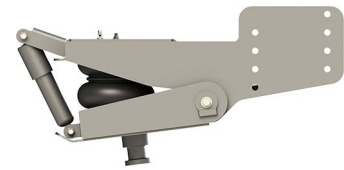

Pin Box Mounting Bolts Required per Side

Pin Box	GVWR	Side Plate	Bolts Required per Side	Component Image
1621	21K	248136 SHD Extended 2481361 SHD Retracted	5	 
1716	15.5K	1191201 Extended 1324791 Retracted	6	 
1621 1716	18K	328330 1621 Rota-Flex	5	
		320734 1716 Rota-Flex	6	
	21K	328329 1621 Rota-Flex	5	
1621 M15	16K	171200 1621 LO5 T/A (OBSOLETE Replaced by 158778)	7	
	18K	155930 1621 LO5 T/A (OBSOLETE Replaced by 158778)	7	
	21K	158778 1621 Long Jaw LO5 T/A	7	
	21K	159430 1621 LO5 T/A (OBSOLETE Replaced by 158778)		

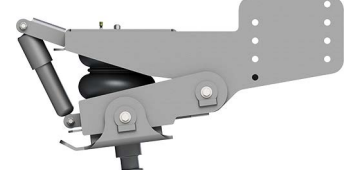

Pin Box Mounting Bolts Required per Side

Pin Box	GVWR	Side Plate	Bolts Required per Side	Component Image
1621 M15	23K	256761 M15 LO5 T/A	7	
1716	21K	158777 1716 Long Jaw LO7 T/A	9	
1621	18K	194170 1621 LO5 T/A Tri-Glide (OBSOLETE)	7	
	21K	277532 1621 LO5 T/A Tri-Glide (OBSOLETE)	7	
1716	21K	229669 1716 LO7 T/A Tri-Glide (OBSOLETE)	9	
	18K	328484 LO5 Medium Jaw T/A Flex-Air	7	
	18K	328492 LO5 Long Jaw T/A Flex-Air	7	
	10K	232275 Cequent Revolution	3	



Pin Box Mounting Bolts Required per Side

Pin Box	GVWR	Side Plate	Bolts Required per Side	Component Image
1716	16K	434150 Cequent Revolution	4	
1621	15.5K	304513 Extended (Mounted in 3rd Hole Down) 304522 Extended (Mounted in Bottom Holes) 306513 Fully Retracted (Mounted in Top Holes)	4	
	18K	304514 HD Extended 304514 HD Retracted	5	
	21K	304519 SHD Retracted 3045191 SHD Extended	5	
1716	18K	304515 1716 Extended 304516 1716 Retracted	6	
1116	18K	304521 1116 Extended - (OBSOLETE) 304517 1116 Retracted	6	
Nar-Long	16K	304520 Narrow-Long	6	
Revolution	10K	361556 Revolution	2	